

UNIFIX 1.C 30

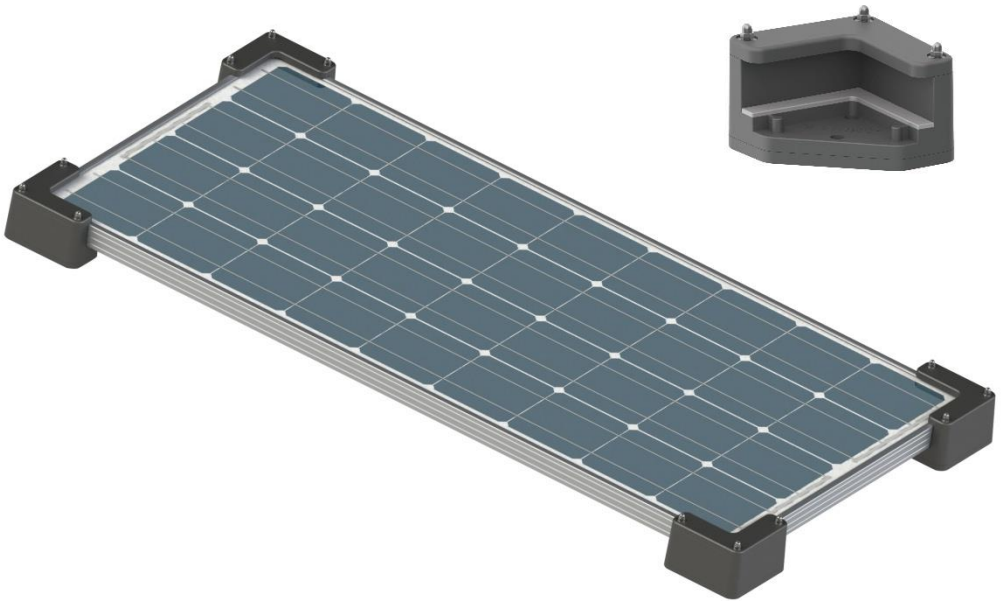

- FR** Le support de fixation camping-car p.2-8
- EN** The mounting bracket for Campervan p.9-15
- ES** El soporte de fijación especial campervan p.16-22
- IT** Il supporto di fissaggio per camper p.23-29

Cher client, nous vous remercions pour votre achat de l'un de nos produits Uniteck. Veuillez lire avec attention toutes les instructions avant d'utiliser le produit.

Le support Unifix 1C 30 a été conçu pour être utilisé sur une surface plane (ex : toit de camping-car, mobile home, péniche...).

CONSIGNES DE SÉCURITÉ

- Prenez les mesures appropriées pour prévenir les accidents pendant vos travaux de montage.
- Si le support et le matériel de montage sont exposés aux rayons du soleil pendant une longue période, il y a un risque de brûlure. Protégez-vous.
- A la fin des travaux, vérifiez que vos supports et panneaux soient bien fixés

UNIFIX - COMPOSITION

Éléments fournis

				
x4	x4	D5 x12	D5 x12	M5 x12
				
X4 Cale basse	X4 Cale blocage	x1 colle	X1 dégraissant	

Prévoir pour le montage, un chiffon légèrement humide



Pour les étapes de nettoyage avant collage : utilisez uniquement un chiffon humide et le dégraissant fourni. Ne pas utiliser d'alcool/ de white spirit.

Respectez 24 heures de temps de séchage. Ne pas bouger ou manipuler pendant cette période.

Le Sika flex doit être appliqué à une température comprise entre 5°C et 35°C, la température optimum d'application étant entre 15°C et 25°C.

UNIFIX - FIXATION PANNEAU

Votre surface doit être propre, sèche, exempte de graisse et dépoluée. Nettoyez au préalable la surface avec un chiffon humide (non fourni), puis laissez sécher quelques minutes. (ne pas utiliser d'alcool/ de white spirit)

- Installez la cale basse puis la cale de blocage sur les quatre coins.

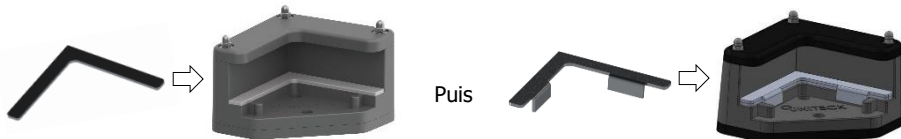

- Fixez les 4 supports Unifix sur votre panneau.

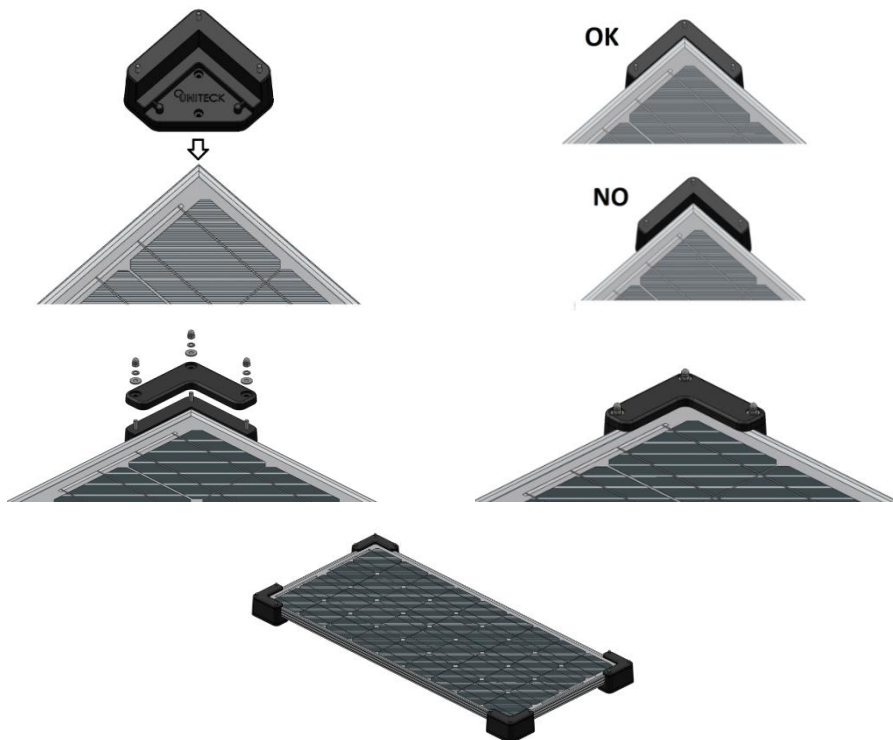

- Nettoyez la zone de pose de vos supports avec le dégraissant fourni. (Ne pas utiliser d'alcool/de white spirit...).

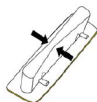

UNIFIX - FIXATION PANNEAU (SUITE)

- Posez à blanc (sans colle) votre panneau à l'endroit souhaité.

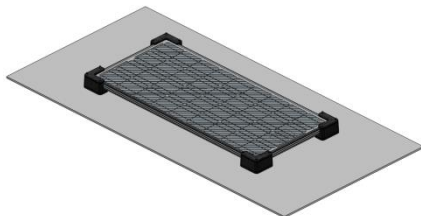

- Réalisez un marquage autour des supports pour visualiser le positionnement des supports.

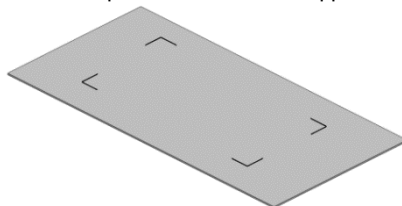
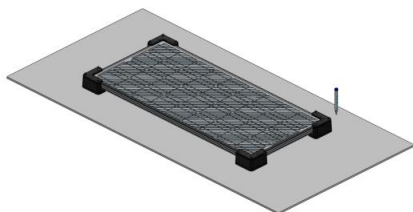

- Enlevez vos angles du panneau, puis appliquez la colle sur vos 4 supports comme indiquée en blanc sur le visuel

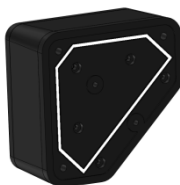
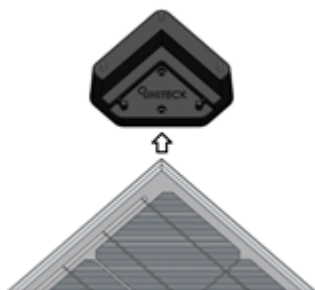

- Repositionnez les supports sur les marquages préalablement réalisés. Réalisez une pression brève de haut en bas.

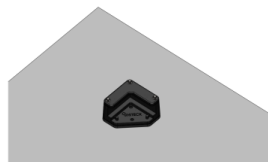

Respectez 24 heures de séchage. Ne pas manipuler pendant  **de temps de boucher ou cette période.**

Pendant ce temps d'attente, vous pouvez réaliser la pose du passe-toit. (produit non inclus, cf partie passe-toit)

UNIFIX - FIXATION PANNEAU (SUITE)

- Positionnez le panneau sur les angles de fixation.

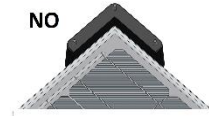
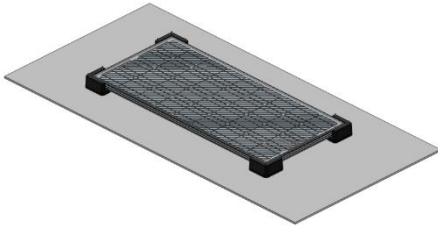

- Fixez les 4 dessus d'angle sur les supports grâce aux rondelles plates, rondelles grower et écrous borgnes.

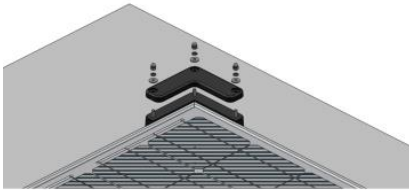

		
D5 X4	D5 X4	M5 X4

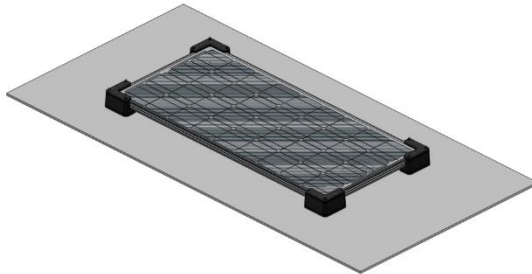

COLLAGE DU PASSE-TOIT (PRODUIT NON INCLU)

- Percez la cloison grâce à une scie cloche. Diamètre compris entre 15 et 20mm.

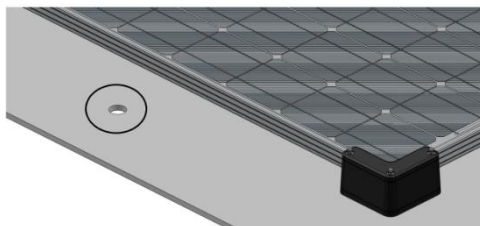

- Nettoyez la zone de pose avec le dégraissant fourni. (ne pas utiliser d'alcool/de white spirit...).



- Appliquez la colle fournie sur la zone indiquée en blanc sur l'image ci-dessous, puis positionnez-le à l'endroit du perçage.

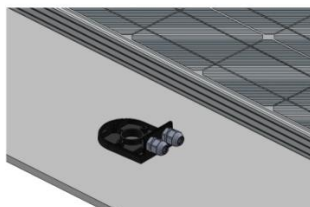

- Passez les câbles. Gardez une longueur suffisante pour votre câblage. Serrez les écrous du presse-étoupe pour assurer une étanchéité.

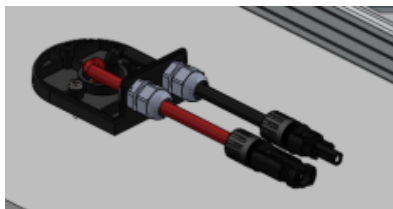
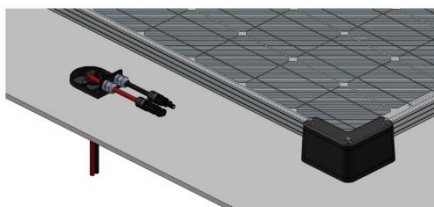

COLLAGE DU PASSE-TOIT (PRODUIT NON INCLUS)

- Fermez le capot grâce aux 2 vis plastiques.

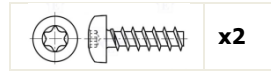
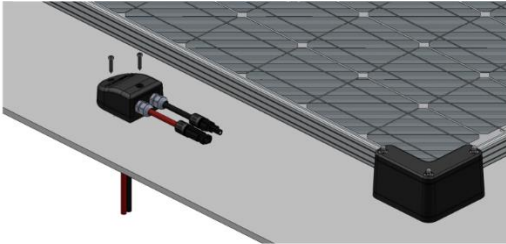

- Raccordez les connecteurs entre eux. (Pas de risque d'erreur, les connecteurs sont polarisés).

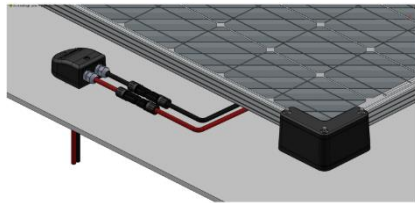
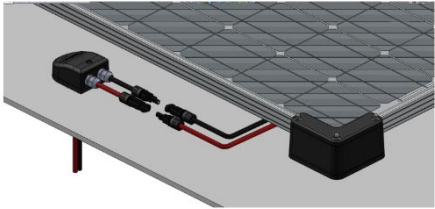

SPÉCIFICATIONS TECHNIQUES

UNIFIX 1.C 30

Dimension	125 x 125 x 85 mm
Poids (avec visserie)	340 g
Visserie	Visserie inox
Pièces plastiques	Nylon polyamide 66 Chargé à 30% en fibre de verre

GARANTIE

La garantie couvre tout défaut ou vice de fabrication pendant 1 an, à compter de la date d'achat (pièces et main d'œuvre).

La garantie ne couvre pas :

- l'usure normale des pièces
- les erreurs de montage

En cas de défauts, retournez le produit à votre distributeur, en y joignant :

- un justificatif d'achat daté (ticket de sortie de caisse, facture...)
- une note explicative du défaut.

Attention : notre SAV n'accepte pas les retours en port dû.

Après la garantie, notre SAV assure les réparations après acceptation d'un devis.

Contact SAV :

Uniteck- 1 Avenue de Rome

Zae Via Europa - bâtiment Cassis

34350 Vendres -France

France mail: sav@uniteck.fr

Fax: +33 (0)4 88 04 72 20

Dear customer, thank you for purchasing one of our Uniteck products. Please read all the instructions carefully and thoroughly before using the product.







The Unifix 1C 30 mounting bracket has been designed to be used on a flat surface (ex.: campervan roof, houseboat).

SAFETY INSTRUCTIONS

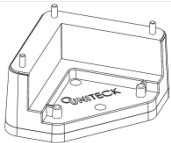
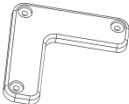
- Take the appropriate measures to prevent accidents during your mounting steps.
- If the bracket and the mounting tools are exposed to sunlight for a long period, there is a risk of getting burnt. Make sure to protect yourself accordingly.
- When finished, check and ensure that all of your brackets and panels are fixed properly.

UNIFIX - COMPOSITION

Provided elements

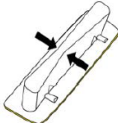
				
x4	x4	D5 x12	D5 x12	M5 x12
				
X4 Low wedge	X4 Blocking wedge	x1 Glue	X1 Degreaser	

For the mounting, make sure you have a slightly wet cloth.

For the preparation of the surface before gluing the brackets: only use a wet cloth and the degreaser provided. Do not use alcohol/white spirit...



Respect 24 hours of drying time. Do not move or manipulate during this time.

Sika flex must be applied at a temperature between 5°C and 35°C, the optimum application temperature being between 15°C and 25°C.

UNIFIX – PANEL FIXING

Your surface must be cleaned, dried, without grease or dust. Beforehand, clean the surface with a wet cloth (not provided), then let it dry for a few minutes (do not use alcohol/white spirit).

- Install the low wedge and then the blocking wedge on all four corners.

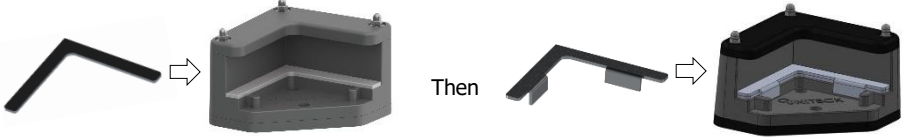

- Fix the 4 brackets on your panel

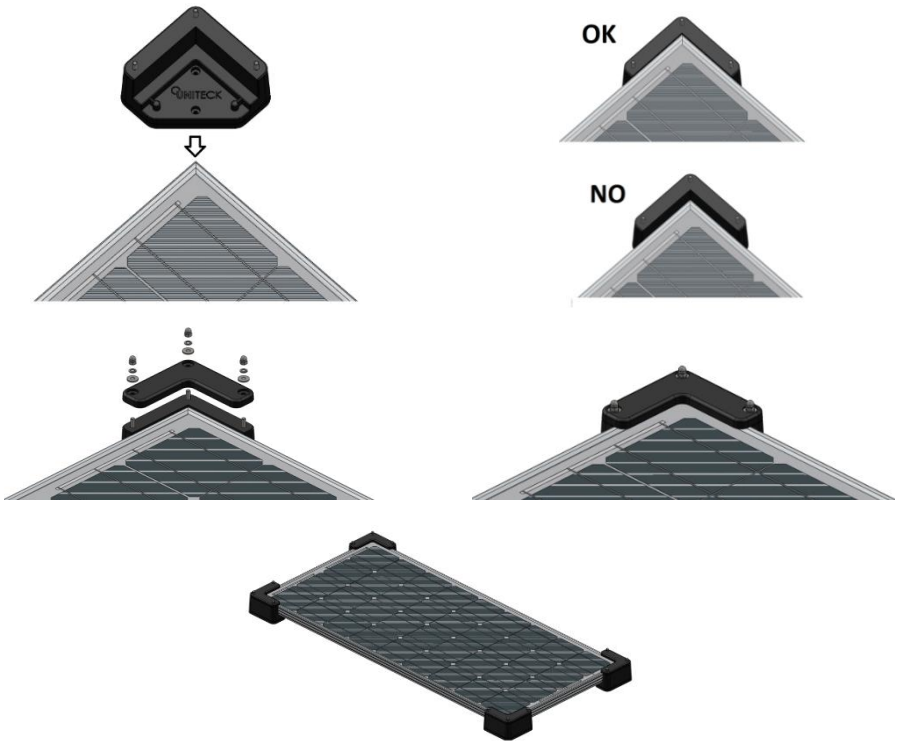

- Clean the bottom of the brackets (area that will get glued) with the degreaser provided (do not use alcohol/white spirit...).

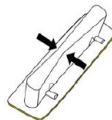

UNIFIX – PANEL FIXING

- Place your panel in the desired position (without glueing)

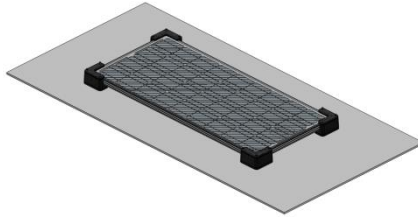

- Place a mark around the brackets to visualise the mounting zone

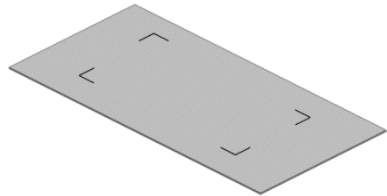
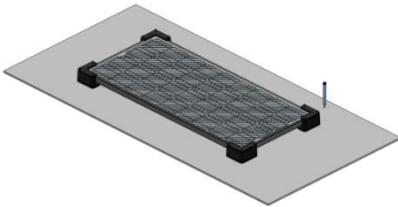

- Remove the angles from your panel then Put the glue on your 4 brackets as indicated in white on the picture

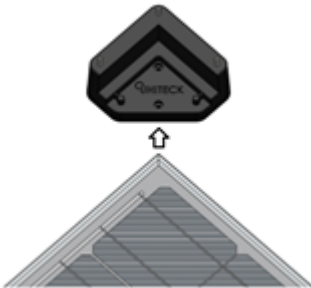

- Place the brackets on the previously marked surfaces. Press briefly down on the brackets.

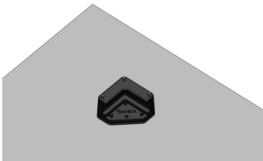

**Respect 24 hours of
move or manipulate**



**drying time. Do not
during this period.**

During this waiting time, you can fix the roof pass (cf roof pass part).

UNIFIX – PANEL FIXING

- Put the panel on the fixing angles.

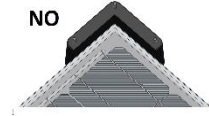
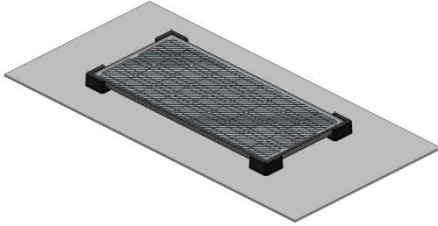

- Fix the 4 upper parts of the angles on the brackets using the flat washers, the lock washers and the cap nuts

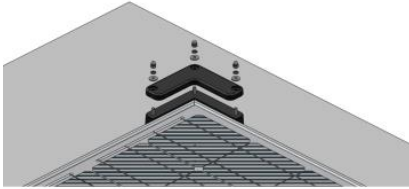

		
D5 X4	D5 X4	M5 X4

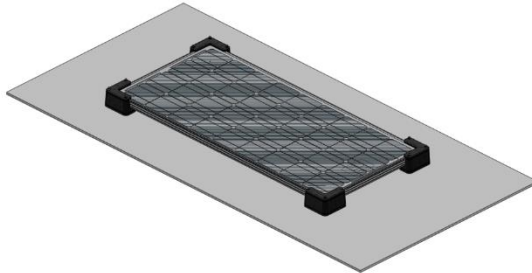

ROOF PASS FIXING (PRODUCT NOT INCLUDED)

- Drill a hole using a hole saw. Diameter between 15 and 20mm

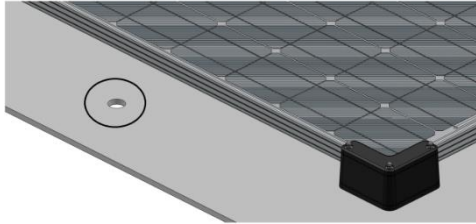

- Clean the fixing zone with the provided degreaser (do not use alcohol/white spirit...).



- Put the provided glue on the area indicated in white on the picture below, then put it over the drilling hole.

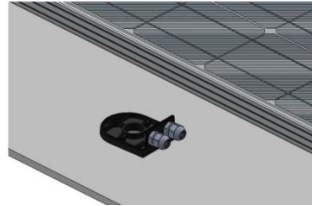

- Pass the cables as seen on the picture below. Keep a sufficient length for the connection. Tighten the nuts of the cable gland to ensure waterproofness

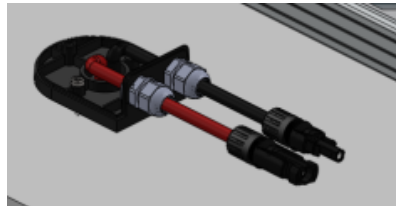
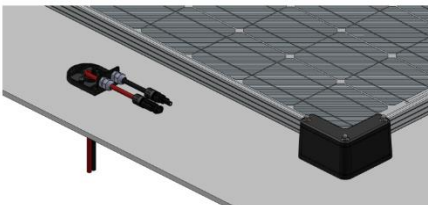

ROOF PASS FIXING (PRODUCT NOT INCLUDED)

- Close the cover with the 2 plastic screws

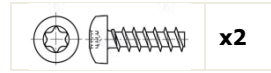
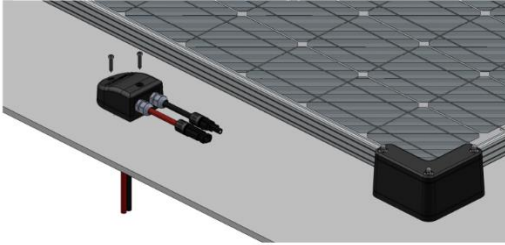

- Connect the connectors between them. (No risk of error, connectors are polarized).

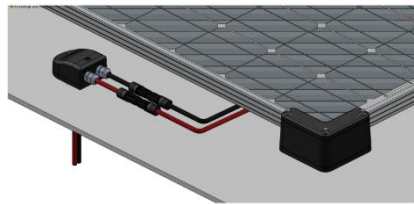
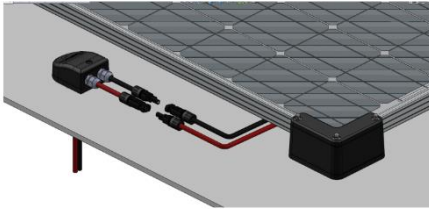

TECHNICAL SPECIFICATIONS

UNIFIX 1.C 30

Dimension	125 x 125 x 85 mm
Weight (with fastenings)	340 g
Fastening	Inox fastening
Plastic elements	Polyamide nylon 66 + 30% added glass fibre

WARRANTY

The warranty covers any defect, manufacturing flaws for 1 year from the date of its purchase (Pieces and workforce).

Warranty does not cover:

- normal wear of parts
- faulty mounting of bracket

In case of failure, return the product to your distributor by attaching:

- the dated proof of purchase (receipt, bill...)
- explanatory note of the failure

Caution: Our after-sales service does not accept carriage forward/ collected returns.

After the warranty, our after-sales service ensures repairs after acceptance of a quotation.

After-sales service contact :

Uniteck- 1 Avenue de Rome

Zae Via Europa - bâtiment Cassis

34350 Vendres -France

E-mail : sav@uniteck.fr

Fax : +33 (0)4 88 04 72 20

Estimado cliente, gracias por comprar nuestro producto Uniteck. Por favor lea con cuidado todas las instrucciones antes de usar el producto.

El soporte Unifix 1C 30 está previsto para estar usado sobre una superficie plana (ej: tejado de autocaravana, casa móvil, barcaza...).

CONSIGNAS DE SEGURIDAD

- Tome las medidas apropiadas para prevenir los accidentes durante sus trabajos de montaje.
- Si el soporte y equipamiento de montaje están expuestos a los rayos del sol durante una larga duración, hay un riesgo de quemadura. Protéjase.
- En fin de los trabajos, verifique que sus soportes y paneles están bien fijados.

UNIFIX - COMPOSICIÓN

Elementos provistos

				
x4	x4	D5 x12	D5 x12	M5 x12
				
X4 Calzo bajo	X4 Calzo de bloqueo	x1 Pegamento Sika	X1 Desengresante	

Pever para el montaje un trapo ligeramente húmedo.

Para las etapas de limpieza antes de pegar: use únicamente un trapo suave y el desengresante provisto. No use alcohol/aguarrás...



Respete 24 horas de duración de secado. No mueva o manipule durante este periodo

Sika flex debe aplicarse a una temperatura entre 5°C y 35°C, siendo la temperatura óptima de aplicación entre 15°C y 25°C.

UNIFIX – FIJACIÓN DEL PANEL

Su superficie debe estar limpia, seca, sin grasa y sin polvo. Limpie previamente la superficie con un trapo húmedo (no provisto), y después deje secas algunos minutos (no use alcohol o aguarrás).

- Instale el calzo bajo y luego el calzo de bloqueo en las cuatro angulos de fijación.



- Fije los 4 soportes Unifix sobre su panel.

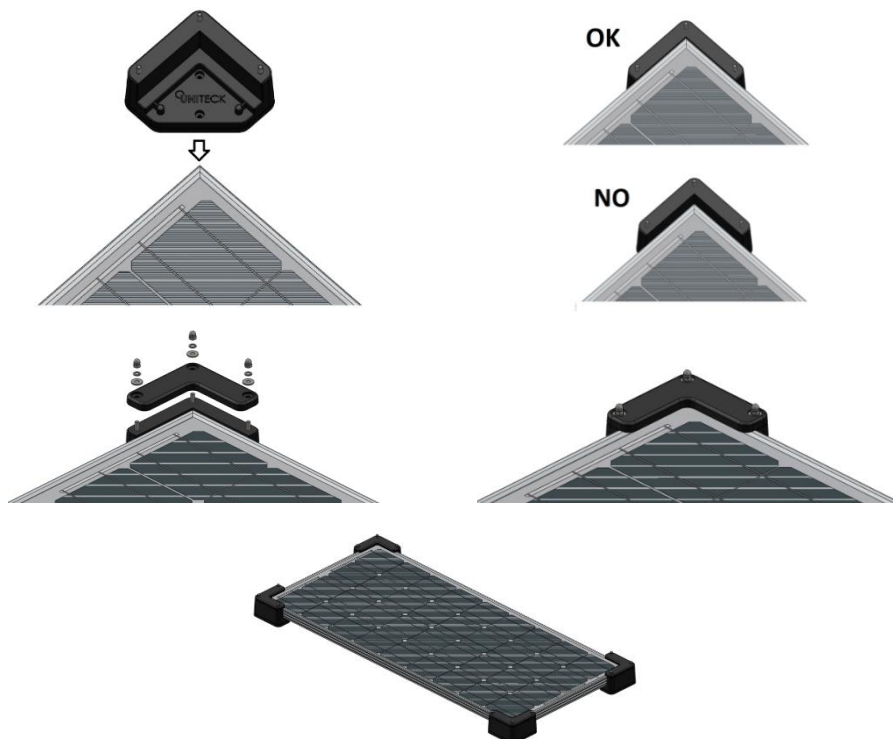

- Limpie la zona de colocación de sus soportes con el desengrasante provisto (no use alcohol, aguarrás....).

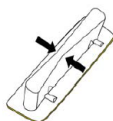

UNIFIX – FIJACIÓN DEL PANEL

- Coloque su panel sin pegamento al lugar deseado

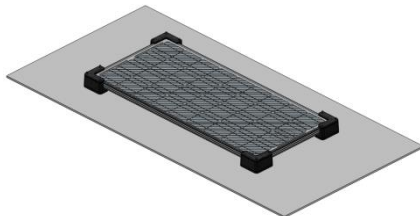

- Realice una marcacion alrededor de los soportes para visualizar el posicionamiento de los soportes.

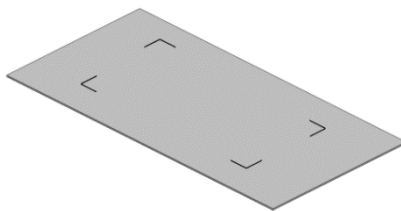
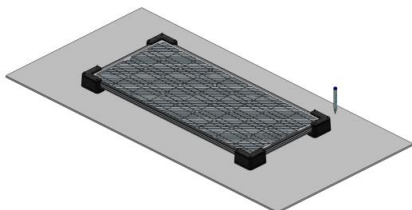

- Quite los angulos del panel, despues Aplique el pegamento sobre sus 4 soportes en la zona indicada en blanco en la imagen

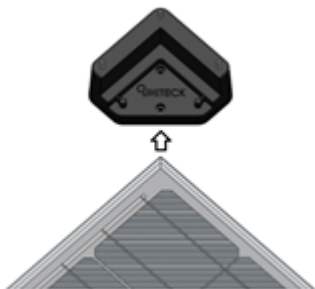

- Coloque de nuevo los soportes sobre las marcaciones previamente realizados. Realice una presión breva desde abajo hasta arriba.

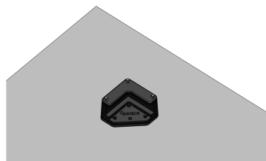

Respete 24 horas de tiempo de secado. No mueva o manipule los elementos durante este periodo.

Durante este tiempo de espera, realiza la colocación del pasatecho.
(producto no incluido, cf parte paso del tejado)

UNIFIX – FIJACIÓN DEL PANEL

- Posicione el panel sobre los ángulos de fijación.

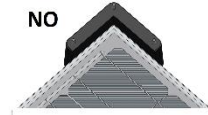
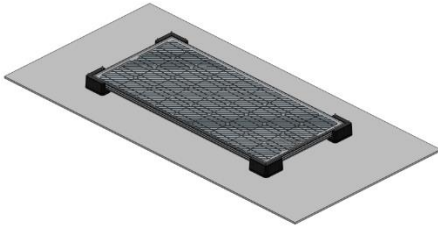

- Fije las 4 parte superiores de los ángulos sobre los soportes gracias a las 4 arandelas platas, rondelas grower y tuercas de sombrerete.

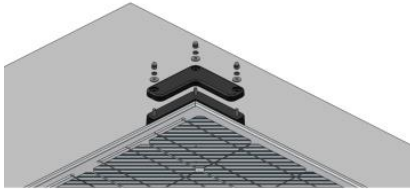

D5 X4	D5 X4	M5 X4

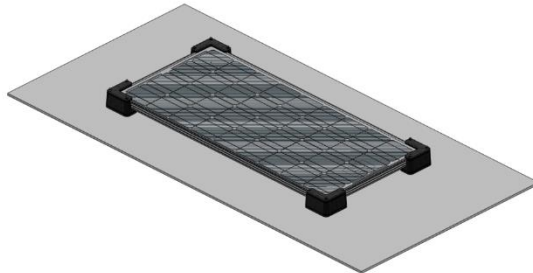

INSTALACIÓN DEL PASO DEL TEJADO (PRODUCTO NO INCLUIDO)

- Agujeree el tabique con una sierra de corona. Diámetro incluso entre 15 y 20mm

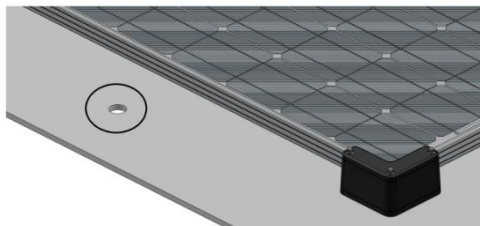

- Limpie la zona de colocación con el desengrasante provisto (no usar alcohol o aguarrás).

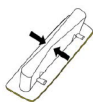

- Aplique el pegamento provisto sobre la zona indicada en blanco en la imagen más abajo, y después colóquelo en el lugar de la perforación.

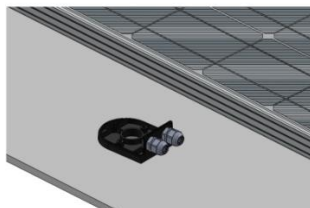

- Pase los cables. Conserve una longitud suficiente para su cableado. Apriete las tuercas de los prensaestopas para asegurar la impermeabilidad.

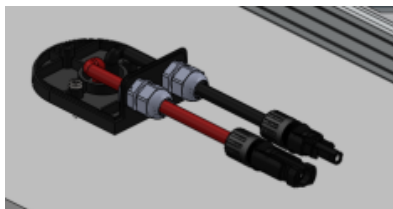
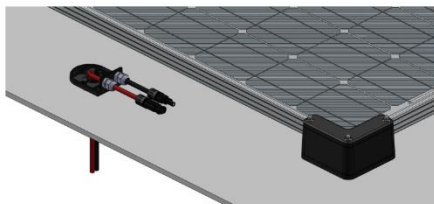

INSTALACIÓN DEL PASO DEL TEJADO (PRODUCTO NO INCLUIDO)

- Cierre la tapa con 2 tornillos plásticos.

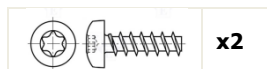
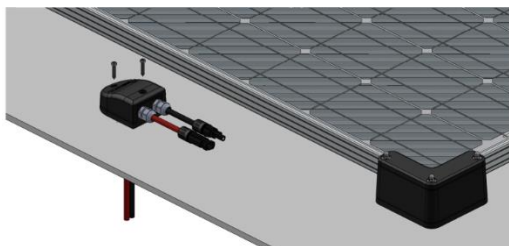

- Conecte los conectores entre ellos (no riesgo de error, los conectores son polarizados).

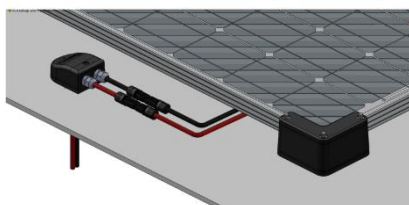
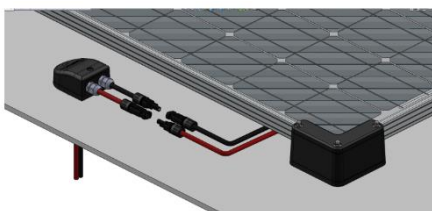

ESPECIFICACIONES TÉCNICAS

UNIFIX 1.C 30

Dimensiones

125 x 125 x 85 mm

Peso (con tornillería)

340 g

Tornillería

Tornillería inox

Piezas plásticas

Nylon poliamida 66

Cargado al 30% en fibra de vidrio

GARANTÍA

La garantía cubra todo defecto o todo vicio de fabricación durante 1 año, desde la fecha de compra (piezas y mano de obra)

La garantía no cubre :

-el desgaste normal de las piezas

En caso de avería, devuelva el aparato a su distribuidor, con :

- un justificado de compra con fecha (tiquete de caja central, factura, ...)

- una nota explicativa de la avería

Cuidado : nuestro Servicio Postventa no acepta devoluciones a portes debidos.

Después la garantía, nuestro Servicio Postventa asegura las reparaciones después aceptación de un presupuesto.

Contacto SAV :

Uniteck- 1 Avenue de Rome

Zae Via Europa - bâtiment Cassis

34350 Vendres -France

France mail: sav@uniteck.fr

Fax: +33 (0)4 88 04 72 20

Gentile cliente, la ringraziamo per il suo acquisto di uno dei nostri prodotti UNITECK. La preghiamo di prendere conoscenza attentamente di tutte le istruzioni, prima di utilizzare il prodotto.

Il supporto Unifix 1C 30 è stato progettato per essere utilizzato su una superficie piana (p.es : tetto di camper, casa mobile, péniche...).

ISTRUZIONE DI SICUREZZA

- Prendere le misure adeguate per prevenire gli accidenti durante i vostri lavori di montaggio.
- Se il supporto e il materiale di montaggio sono esposti al sole per un lungo periodo di tempo, esiste un rischio di ustione. Proteggetevi.
- Alla fine dei lavori, verificare che i vostri supporti e pannelli siano ben fissati.

UNIFIX - COMPOSIZIONE

Elementi forniti

				
x4	x4	D5 x12	D5 x12	M5 x12
				
X4 Zeppa bassa	X4 Zeppa blocco	x1 Adesivo	X1 Sgrassante	

Prevedere per il montaggio, un panno leggermente umido



Per le tappe di pulizia prima dell'incollaggio : utilizzare solo un panno umido e lo sgrassante fornito. Non utilizzare alcol/ acqueragia.

Rispettare 24 ore di tempo di asciugatura. Non muovere o manipolare gli elementi durante questo periodo di tempo.

L'adesivo Sika flex deve essere applicato ad una temperatura compresa tra 5°C e 35°C, la temperatura ottimale d'applicazione si situa tra 15°C e 25°C.

UNIFIX – FISSAGGIO PANNELLO

La vostra superficie deve essere pulita, asciutta, sgrassata e spolverata. Pulire precedentemente la superficie con un panno umido (non fornito), poi lasciate la superficie asciugare qualche minuto. (non utilizzare alcol/ acquaragia)

- Installare la zeppa bassa poi la zeppa di blocco sui 4 angoli.



- Fissare i 4 supporti Unifix sul vostro pannello.

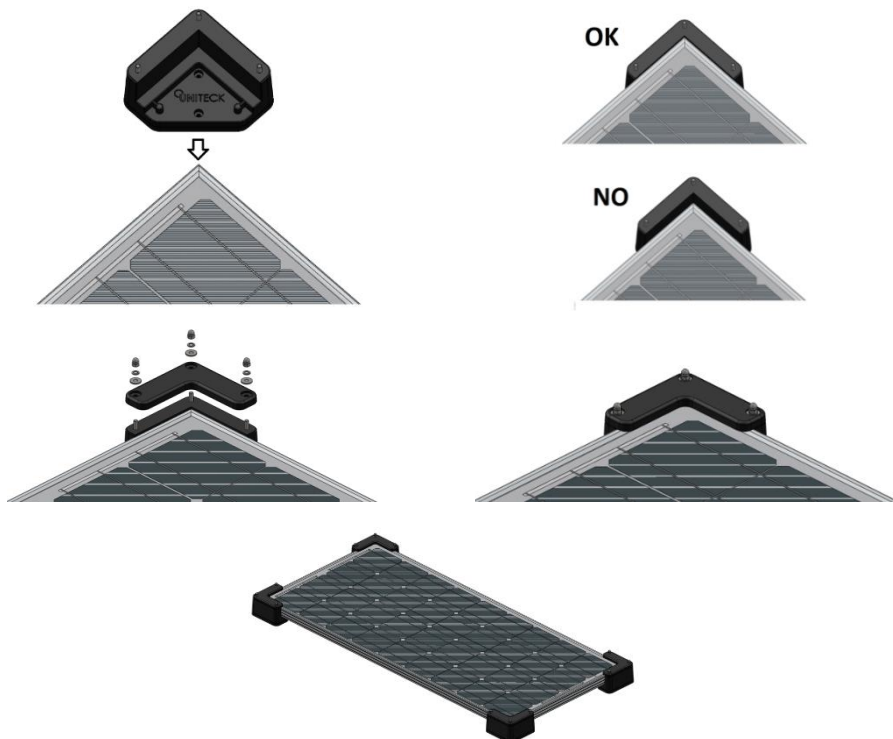

- Pulire la zona posteriore del supporto (la parte che sarà incollata) dei vostri supporti con lo sgrassante fornito. (Non utilizzare alcol/acquaragia...).

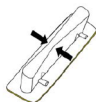

UNIFIX – FISSAGGIO PANNELLO

- Posizionare (senza adesivo) il vostro pannello al posto desiderato.

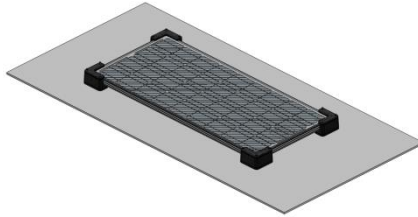

- Tracciare i contorni dei supporti per visualizzare la loro posizione.

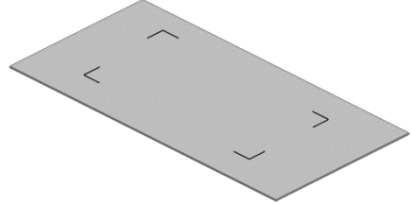
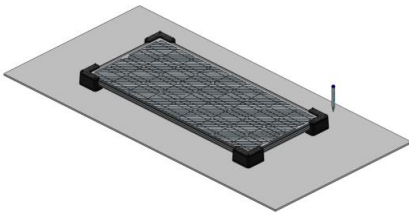

- Rimuovere gli angoli del pannello, poi applicare l'adesivo sui vostri 4 supporti come indicato in bianco sull'immagine.

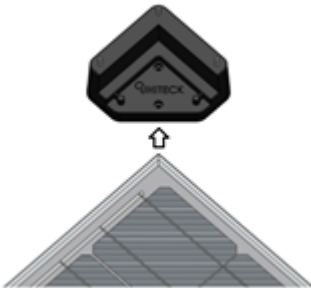

- Riposizionare i supporti sui contorni precedentemente tracciati. Pressare brevemente l'angolo.

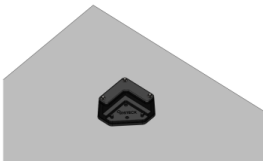

Rispettare un periodo di asciugatura. Non manipolare gli  **di 24 ore di tempo di muovere o elementi durante questo periodo di tempo.**

Durante questo tempo di attesa, potete effettuare l'installazione del passacavo per tetto. (prodotto non incluso, cfr parte passacavo per tetto)

UNIFIX – FISSAGGIO PANNELLO

- Posizionare il pannello sugli angoli di fissaggio.

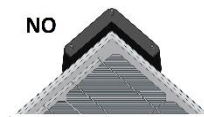
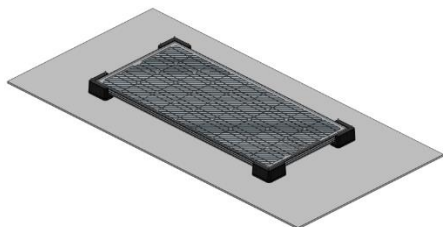

- Fissare le 4 parti superiori degli angoli sui supporti grazie alle rondelle piane, rondelle grover e dadi ciechi.

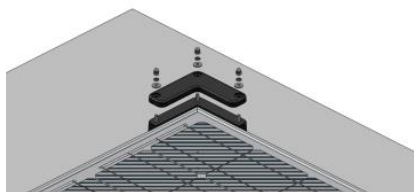

		
D5 X4	D5 X4	M5 X4

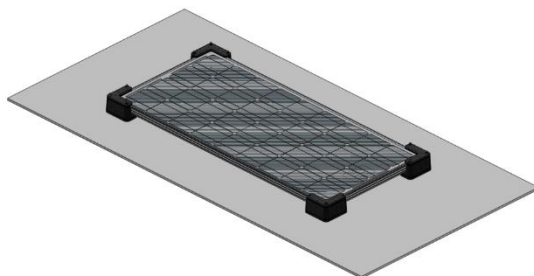

INCOLLAGGIO DEL PASSACAVO PER TETTO (PRODOTTO NON INCLUSO)

- Forare il tetto grazie ad una sega a tazza. Diametro compreso tra 15 e 20mm.

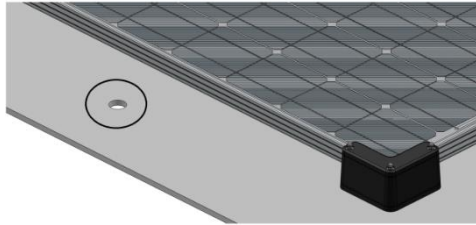

- Pulire la zona d'installazione con lo sgrassante fornito. (non utilizzare alcol/acquaragia...).



- Applicare l'adesivo fornito sulla zona indicata in bianco sull'immagine di cui sotto, poi, posizionare il passacavo al posto dove si trova il foro.

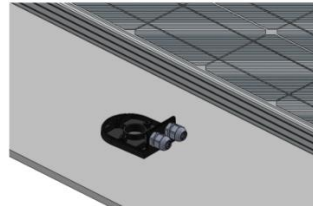

- Passare i cavi. Tenere una lunghezza sufficiente per il collegamento. Serrare i dadi del premistoppa per assicurare la sua impermeabilità.

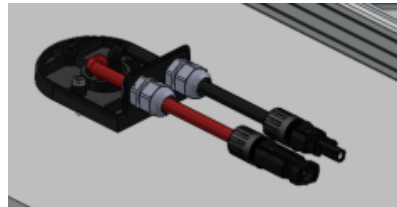
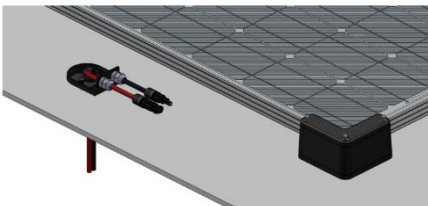

INCOLLAGGIO DEL PASSACAVO PER TETTO (PRODOTTO NON INCLUSO)

- Chiudere il coperchio grazie alle 2 viti plastiche.

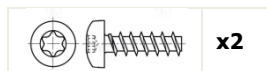
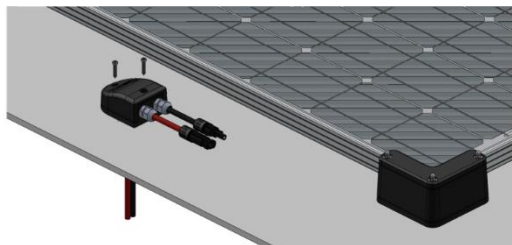

- Collegare i connettori tra di loro. (Nessun rischio di errore, i connettori sono polarizzati).

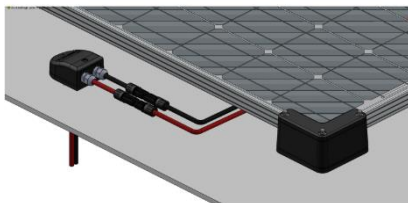
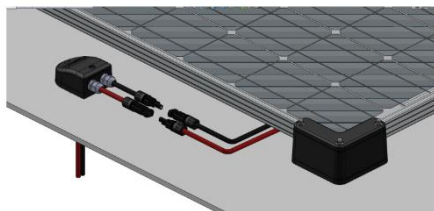

CARATTERISTICHE TECNICHE

UNIFIX 1.C 30

Dimensioni

125 x 125 x 85 mm

Peso (con viti)

340 g

Viti

Viti acciaio inossidabile

Pezzi di plastica

Nylon poliammide 66

Composto al 30% di fibra di vetro

GARANZIA

La garanzia copre difetti o vizi di fabbricazione per 1 anno, a partire della data di acquisto (pezzi e manodopera).

La garanzia non copre :

- la normale usura dei pezzi
- scorretto montaggio

In caso di difetto, restituire il prodotto al vostro distributore, con, in allegato :

- una prova di acquisto datata (scontrino, fattura...)
- una nota che spiega il difetto

Attenzione : il nostro servizio post vendita non accetta restituzioni porto assegnato

Dopo la scadenza della garanzia, il nostro servizio post vendita garantisce i ripari dopo accettazione di un preventivo.

Contatto servizio post vendita :

Uniteck- 1 Avenue de Rome
 Zae Via Europa - bâtiment Cassis
 34350 Vendres -France
 France mail: sav@uniteck.fr
 Fax: +33 (0)4 88 04 72 20